

IR work update

- Preliminary design of extended IR (± 100 m around IP) presented at meeting with Mike Sullivan early February.

- Goal is to have (semi-)final iteration ready before DIS conference (April 22), including:
 - Straight electron straight as per design report spec with only soft wiggles in CCB upstream of detector.
 - Adjust strength of „big“ ion dipole to put beams in parallel after IP.
 - Dual function electron low- Q^2 tagger also including compensation features.
 - Additional low- t ion detection point downstream of secondary focal point but before crab cavity to further improve near-beam tracking.
 - See separate slide
 - Additional compensation elements downstream of all detection points?

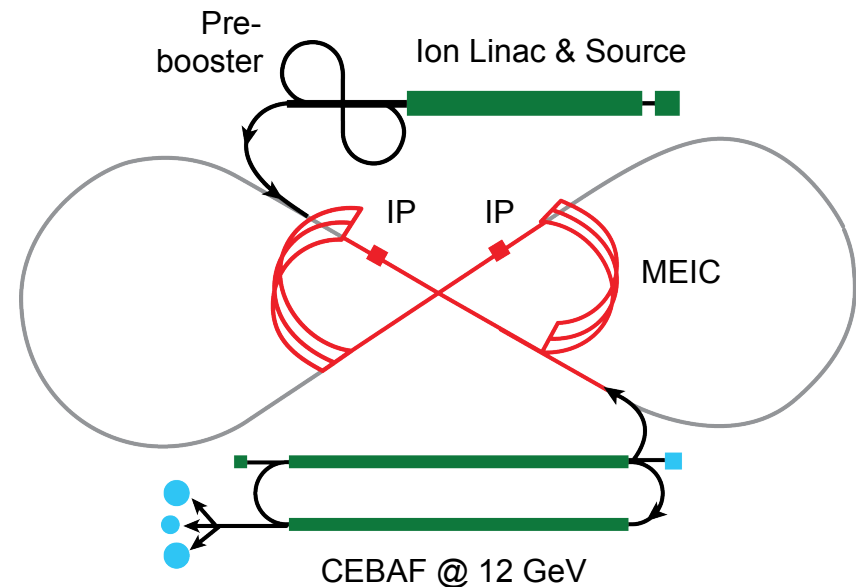

- Asymmetric IR optics for the full-acceptance detector optimized for low chromaticity and high luminosity
 - 2 identical IR:s in lattice

Ultra-forward hadron detection – requirements

1. Good acceptance for ion fragments (rigidity different from beam)

- Large downstream magnet apertures
- Small downstream magnet gradients (realistic peak fields)

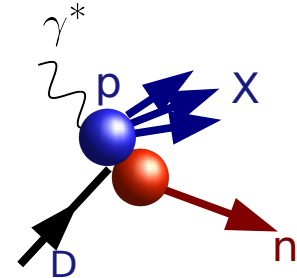

2. Good acceptance for recoil baryons (rigidity similar to beam)

- Small beam size at second focus (to get close to the beam)
- Large dispersion (to separate scattered particles from the beam)

3. Good momentum- and angular resolution

- Large dispersion (e.g., 60 mrad bending dipole)
- Long, instrumented magnet-free drift space

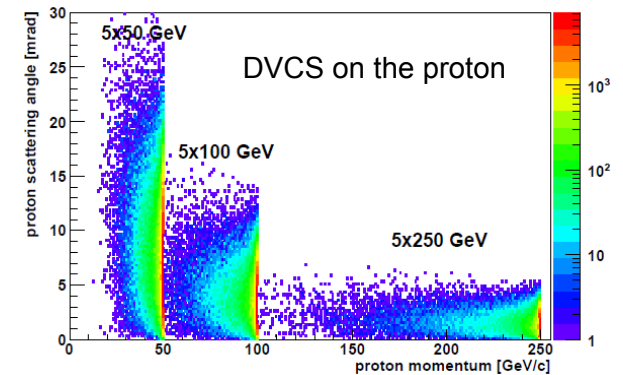

4. Sufficient separation between beam lines (~1 m)

Ultra-forward detection at secondary focal point

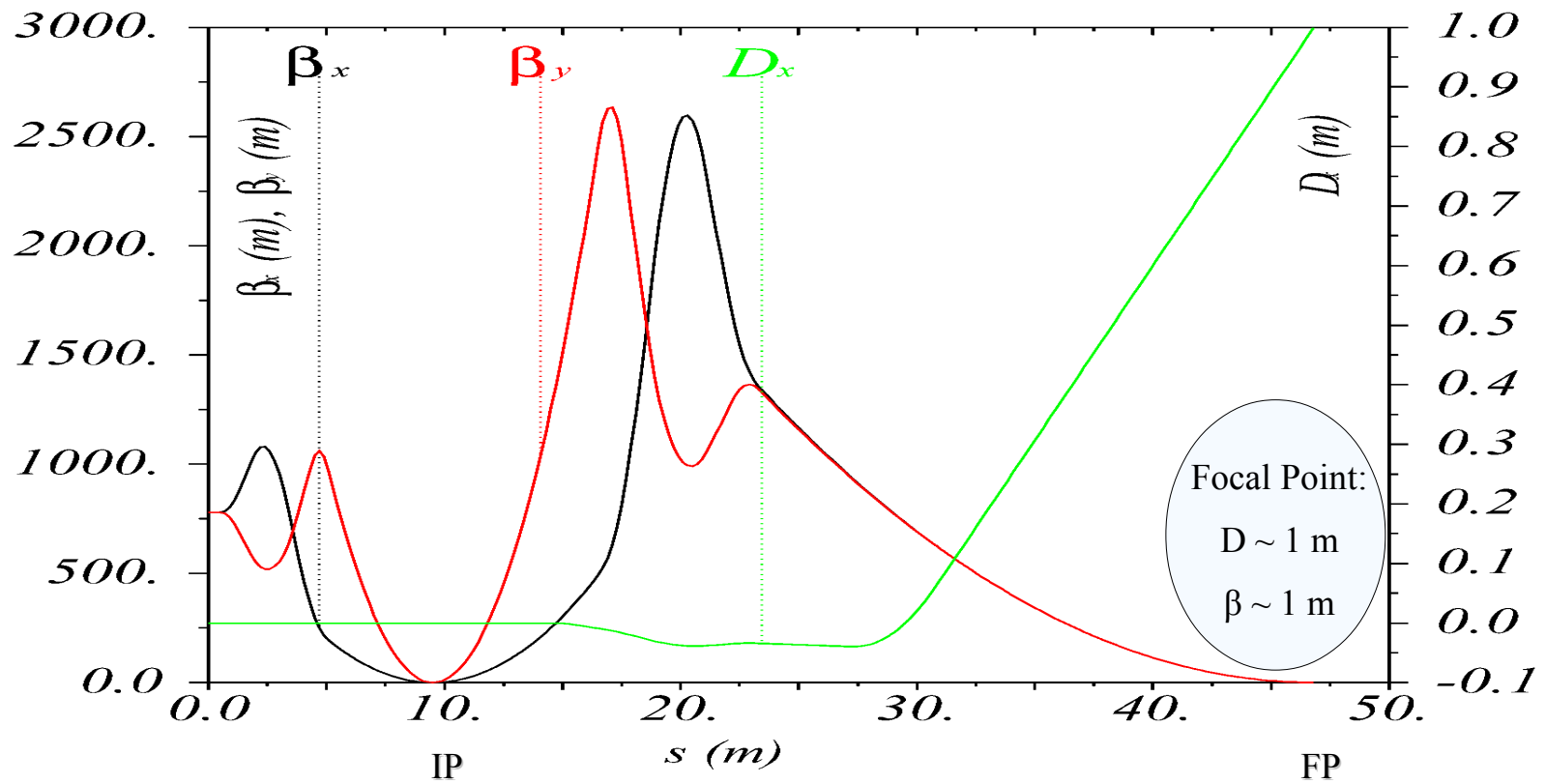
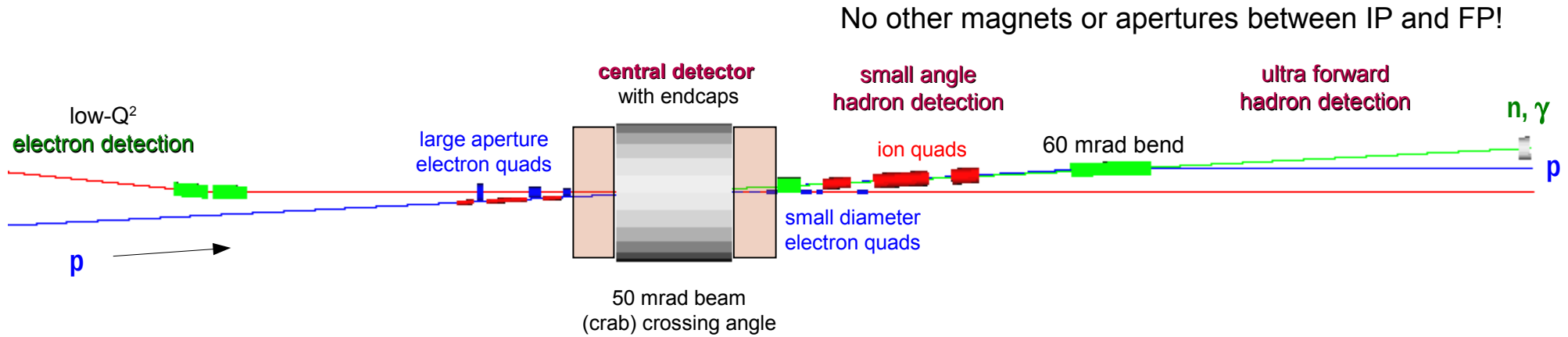

Ultra-forward charged-hadron acceptance

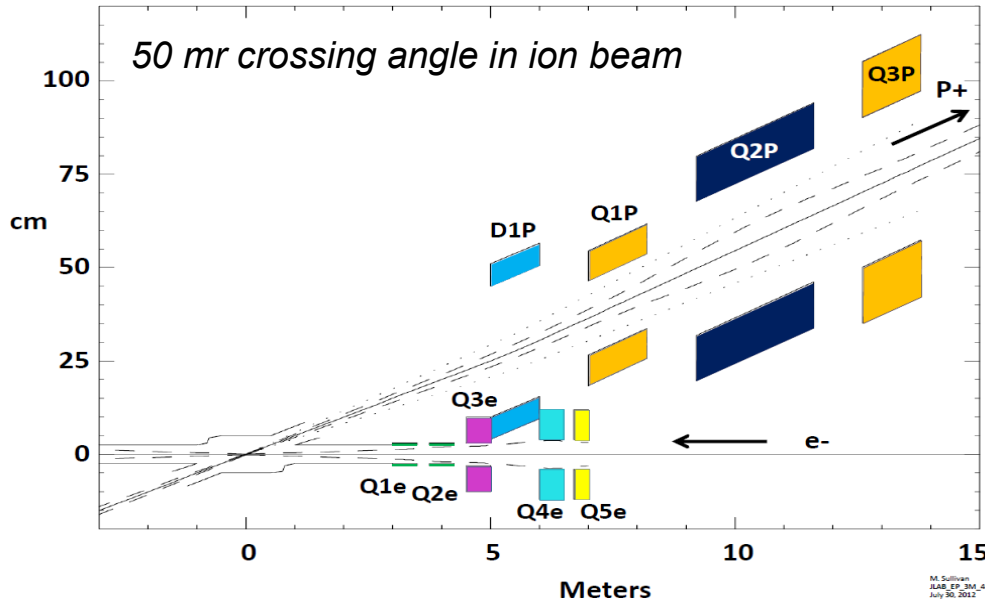

Red: Detection before ion quadrupoles

Blue: Detection after ion quadrupoles

Forward acceptance vs. magnetic rigidity

horizontal plane **vertical plane**

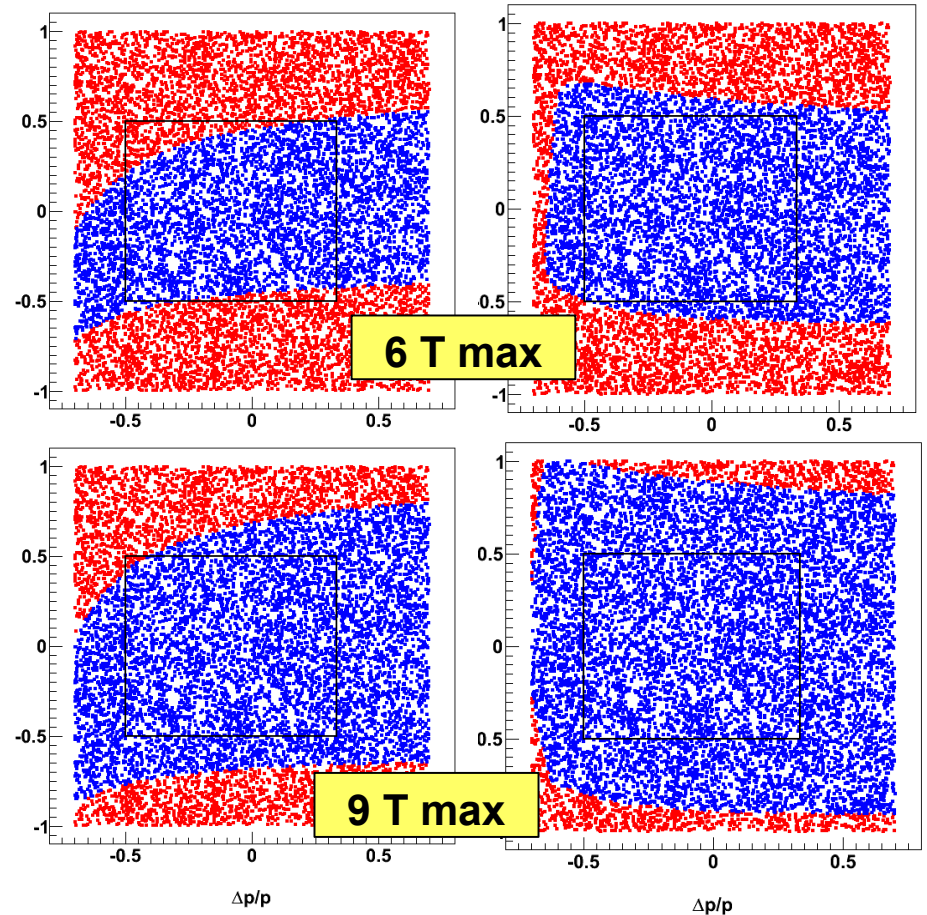

Tagged d beam: $dp/p = -0.5$
Tagged ^3He beam: $dp/p = +0.33$

Ultra-forward detection downstream of focal point

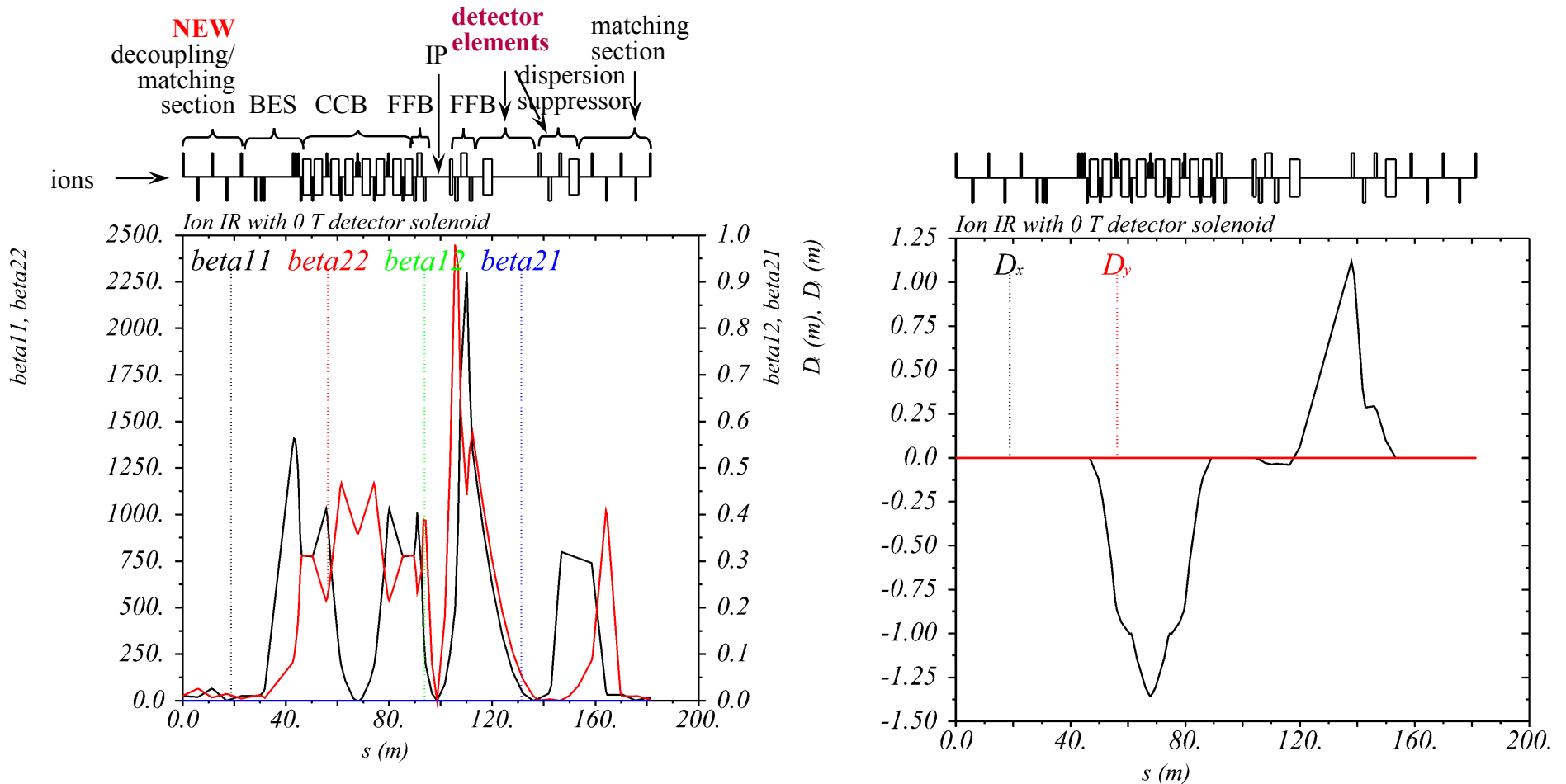

- Dispersion suppression section after the secondary focal point offers an excellent opportunity for supplementary low-t, near-beam detection

Acceptance after dispersion suppressor quads

Assuming 5 cm radius of quad apertures

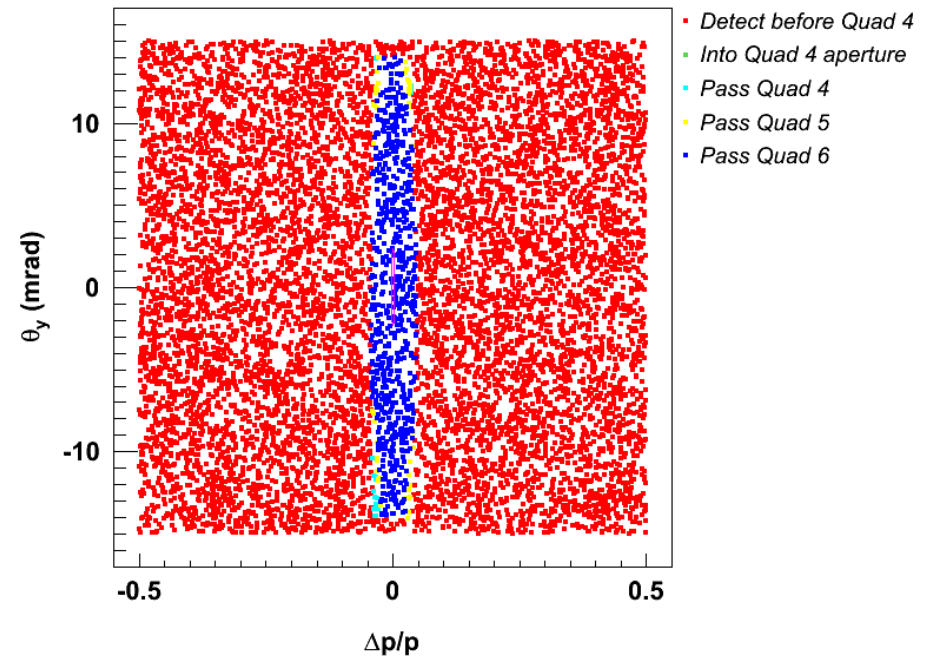
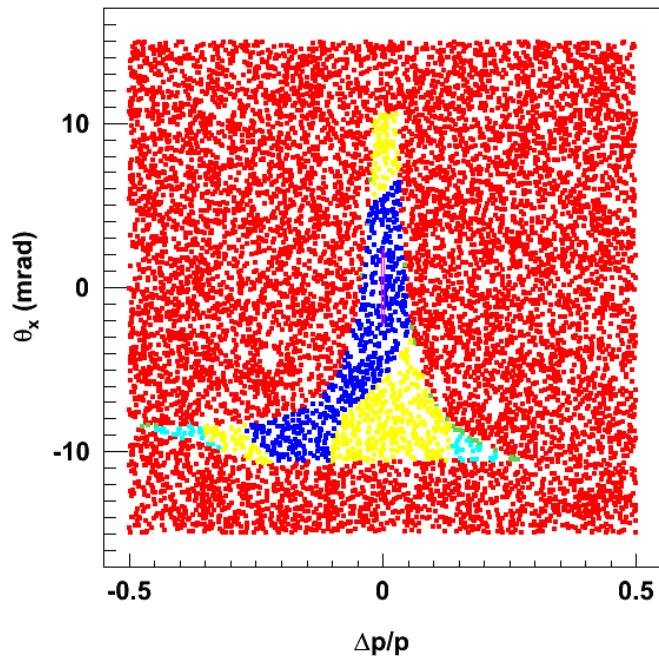

- Recoil baryons with rigidities close to those of the beam can be tracked all the way through the downstream dispersion suppressor quads.
 - Larger separation from beam (simpler detectors)
 - More redundancy determination of scattering angle

Ultra-forward hadron detection – summary

- Neutron detection in a 25 mrad cone *down to zero degrees*
 - Excellent acceptance for *all ion fragments*

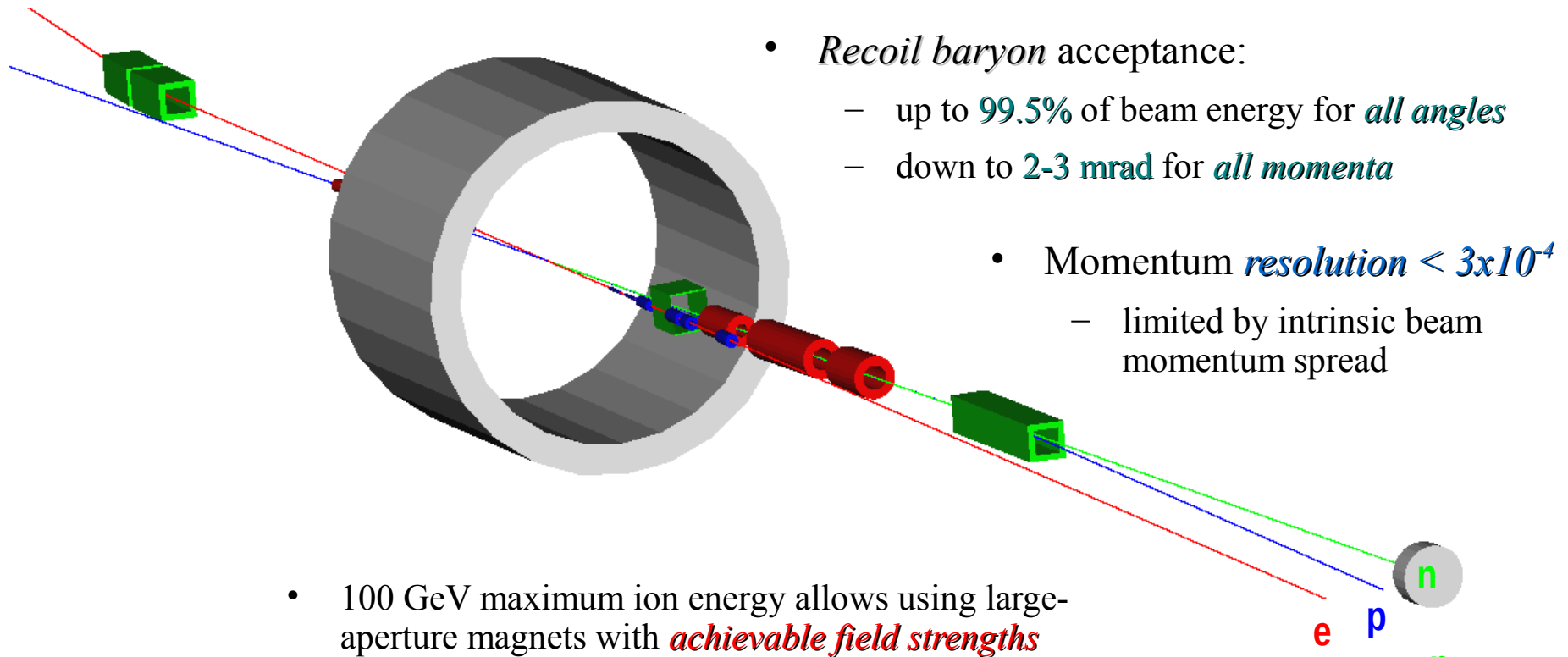

- 100 GeV maximum ion energy allows using large-aperture magnets with *achievable field strengths*

